



LED Wall Washer

GTD-L336P

User's Manual

Guangzhou GTD Lighting Technology Co., Ltd.

Tel: +86-20-61808296

Fax: +86-20-61812282

<http://www.gtd-lighting.com>







©2017 GTD all rights reserved. Information, specifications, diagrams, images, and instructions herein are subject to change without notice. GTD logo and identifying product names and numbers herein are trademarks of GTD. Copyright protection claimed includes all forms and matters of copyrightable materials and information now allowed by statutory or judicial law or hereinafter granted. Product names used in this document may be trademarks or registered trademarks of their respective companies and are hereby acknowledged. All non-GTD brands and product names are trademarks or registered trademarks of their respective companies.

GTD and all affiliated companies hereby disclaim any and all liabilities for property, equipment, building, and electrical damages, injuries to any persons, and direct or indirect economic loss associated with the use or reliance of any information contained within this document, and/or as a result of the improper, unsafe, insufficient and negligent assembly, installation, rigging, and operation of this product.

Contents

Safety instructions	3
General guidelines	4
Packing and shipping	5
Unpacking	5
Packing after use.....	5
Accessories	5
Product introduction	6
Installation	6
Device installation	6
Power / Control connection	7
Power connection	7
Control connection	7
Testing	8
Control panel	8
Menu structure	9
DMX protocol	10
Technical specification	12
Cleaning and maintenance	13
Troubleshooting	14
System wiring diagram	15
Spare parts list	16
Appendix 1	16

Safety instructions

	<p>WARNING!</p> <p>Before using the fixture, read the latest version of the product user manual, paying particular attention to the safety instructions. Please check www.gtd-lighting.com for the latest revision/update of the user manual. The manufacture of this fixture, are not responsible for damages, resulting from misuse of this fixture, due to the disregard of the information printed in this user manual.</p>
	<p>DANGER!</p> <p>Hazardous voltage. Risk of lethal or severe electric shock.</p>
	<p>WARNING!</p> <p>Burn hazard. Hot surface. Do not touch.</p>
	<p>WARNING!</p> <p>Fire hazard.</p>
	<p>It's essential that the fixture is properly grounded. Only qualified personnel should perform electrical connections.</p>
	<p>WARNING!</p> <p>Wear protective eyewear. Never look directly into the light source.</p>

- Only qualified and certified personnel should perform installation of this fixture and only the original rigging parts (brackets) included with this fixture should be used for installation.
- Before applying power to the fixture, check that the source voltage matches the fixture's requirement. Every fixture must be earthed (grounded) and installed in accordance with local electricity regulations. Do not connect it to a dimmer system.
- Never look directly into the light source of this fixture to prevent risk of injury to your retina, which may induce blindness.

General guidelines

- Never open this fixture while in use.
- The fixture should be kept clean. **DO NOT** operate the fixture in extreme heat or dusty environments. Avoid contact with chemical liquid.
- IP rating: IP65. It should be kept away from the high ambient or dusty environments. Don't let the fixture contact with chemical liquids.
- **Minimum** distance to lighted objects must be **3.28feet (1m)**.
- **Maximum** temp of the external surface **167°F (75°C)**.
- **Maximum** ambient temperature **113°F (45°C)**.
- **Minimum** distance of inflammable materials from the surface **1.6 feet (0.5m)**.
- LED lamp should be changed if damaged or distorted in shape due to extreme heat.
- Cover, lens or display screen with visible damages such as cracks or scratches must be replaced to ensure performance of the fixture.
- Disconnect the fixture from power before changing any parts or accessories.
- Make sure that the installation area can hold a minimum point load of 10 times the weight of all installed fixtures, cables, auxiliary equipment, etc. Certified safety cables must always be used when installing the fixture.
- The fixture is only intended for installation, operation and maintenance by qualified professional. Instructions stated in the manual must be complied.
- The fixture must be kept in a well-ventilated place at least 50 cm away from any wall surface. Check if the fans or ventilation openings are unblocked.
- Broken or damaged cables can only be fixed or changed by certified technicians, certified local distributors or the manufacturer to ensure operational safety.
- Do not stick filters or other materials onto the lens. Do not modify the fixture or install other than GTD manufactured parts.
- For questions regarding safety operation, please contact our technical personnel or call the service hotline +8620 61808296.

Packing and shipping

Unpacking

Notes

All products are quality controlled and checked for any faults before they are dispatched to customers. If the fixture is damaged during delivery, the customer must notify the shipper and manufacturer to file a damage insurance claim. Photographic evidence of the damage must be provided.

Flight-Case

Open the cover of the flight-case and remove the plastic packing bags. Hold the handles of the fixture firmly and take it out carefully.

Cardboard box

Open the box and take out the whole set of packaging foam which contains both the fixture and its accessories. Remove the foam from the top, put away the accessories, and then take out the fixture wrapped in the plastic bag.

Packing after use

1. Switch off the fixture and wait for at least 5 minutes before disconnecting it from AC power. Cool down the fixture for at least 15 minutes before packing.
2. Flight case: Wrap the fixture in plastic bags. Hold it by the handles, and then carefully place it inside the flight case along with all the accessories. Close the cover. Do not upside down.
Cardboard box: Wrap the fixture in plastic bags. Put it in the packaging foam along with all the accessories. Place the other set of packaging foam on top then carefully put it inside the cardboard box.

Accessories

Item	Qty	Unit	Notes
User Manual	1	pc	
Barn door	1	pc	440*16.5*61mm
Waterproof power cable (female)	1	pc	0.5*2.5mm ² IP67

Notes

Accessories are subject to change without any prior written notice.

Product introduction

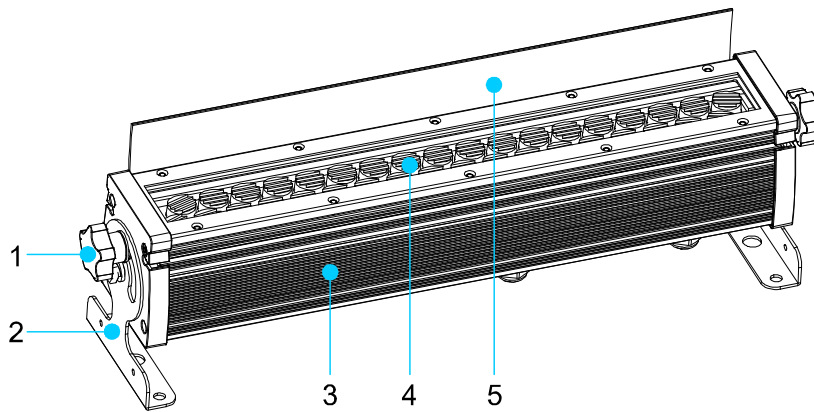

- | | | | | | |
|---|------------------------|---|-----------|---|--------------------|
| 1 | Manual adjusting screw | 2 | Bracket | 3 | Cast aluminm cover |
| 4 | LED lens | 5 | Barn door | | |

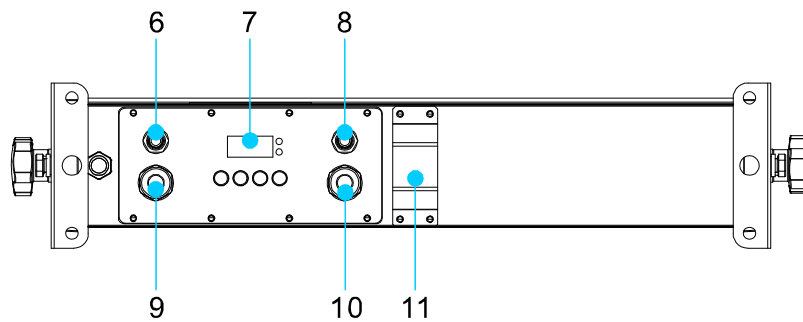

- | | | | | | |
|---|-------------|----|--------------|----|--------------------------------|
| 6 | DMX input | 7 | Display | 8 | DMX output |
| 9 | Power input | 10 | Power output | 11 | Safety cable mounting position |

Installation

Device installation

This fixture can be installed on stage or mounted in any directions.

On the wall:

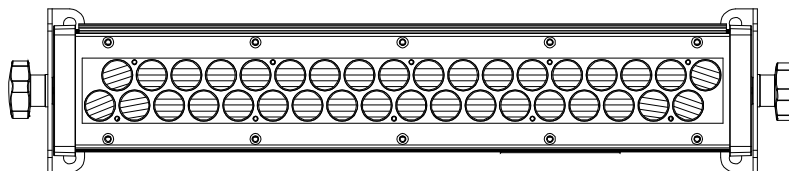

On the ground:

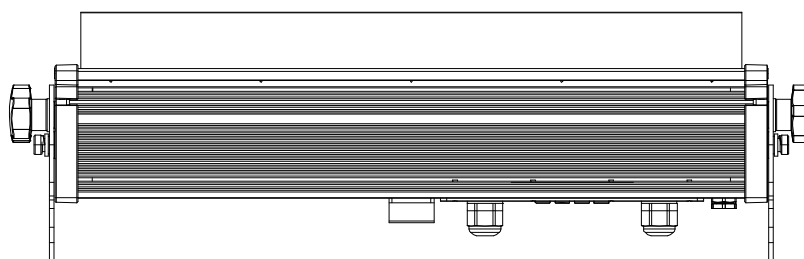

Power/ Control connection

Power connection

Connection method:

- L (Live) Brown wire
- E (Earth) Yellow / Green bi-color wire
- N (Neutral) Blue wire
- The voltage and frequency of the power source must be in compliance with the ones marked on the fixture. Please apply series connection when many sets of fixtures are connected to the power source to avoid heavy load to the power source. When the voltage is 110V, maximum 10 sets of fixtures could be allowed in each series connection. When the voltage is 220V, maximum 20 sets of fixtures could be allowed in each series connection. Another series connection should be set up for extra fixtures.

⚠Notes

It is essential that each fixture is correctly grounded and the electrical installation conforms to all relevant Standards / Codes of Practice for Safe Electrical Work.

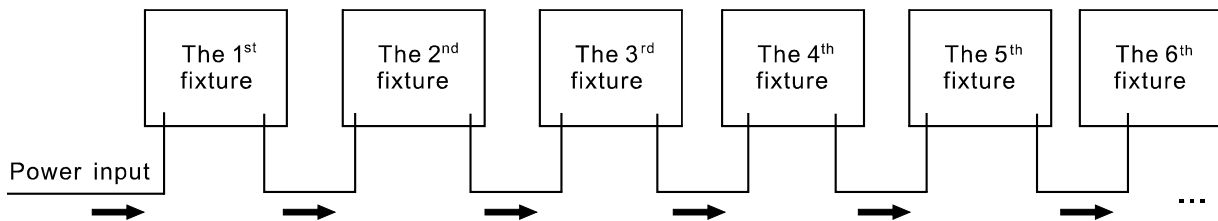

Control connection

The fixture has 5-pin XLR connectors for DMX data input and output (3-pin optional) as shown below. Connection between the console and fixture, and between fixtures must be made with 2 core screened DMX signal cable. Maximum connecting distance of signal cable is 150 meters. Additional DMX512 signal-amplifier are recommended for longer distance.

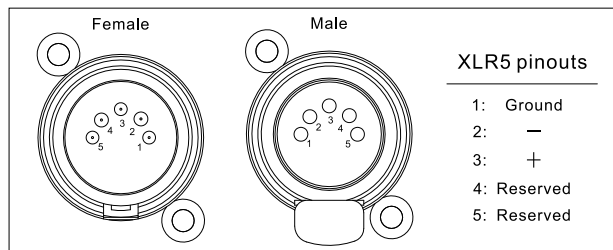

Connect the Console’s DMX OUTPUT to the first fixture’s DMX INPUT, then the first fixture’s DMX OUTPUT to the second fixture’s DMX INPUT and so on. It is recommended not to connect more than 32 units on a single DMX universe. On the last fixture’s output connect a DMX terminator. (The terminator is a XLR connector with a ¼ W and 120Ω resistor between the pin 2 and pin 3) as shown below:

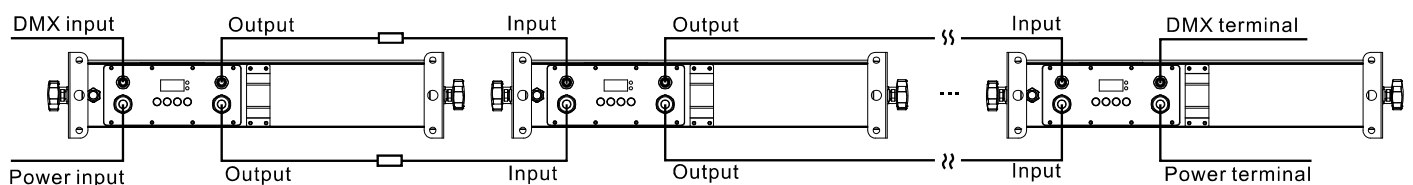

Testing

Connect the fixture to AC power. Check if the LED lamp is on and the fixture is independently controllable before putting into operation.

Control panel

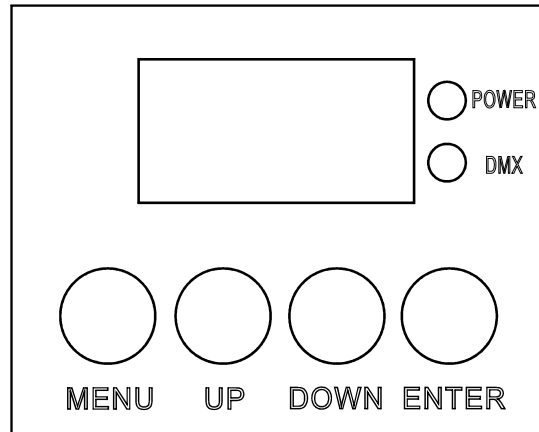

- The control panel with buttons and digital display can access the function menu and configure the fixture easily.
- Press MENU to check or modify the functions of the fixture; Press UP or DOWN to view or select the function menu.
- Press ENTER to choose a function and enter into corresponding sub menu. Each menu represents a specific function of the fixture.
- Press ENTER to select the specific function and save the changes or enter into the submenu, then press UP or DOWN to change the value of the selected function (increase or decrease).
- Press MENU to return to the previous menu or exit.
- LED indicators:
 - Power on: RED power LED indicator on
 - Signal on: Green DMX indicator on
 - No Signal: Green DMX indicator off

Menu structure

L336P – Menu Structure	
Revision: A	Valid from firmware version: 1.0

Level 1	Level 2	Level 3	Level 4	Info	
Addr	Axxx ADD1			Setting the DMX address	
PLAY	rUN	NStr/ALON		Running build-in program as the master or the slave	
	AUd1	NStr/ALON		Receiving sound signal as the master or the slave	
	AUe0	CLOS/HOLD/AUe0/AUd1		Setting the status when no DMX signal received	
CH	CH1			Standard channel mode	
	CH2			Basic channel mode	
MIC	0-xx 0-72			Adjusting the sensitivity of Microphone	
DISP	URLU	d-xx d-00 (dxxx)		Display the channel value	
	dON	ON/OFF		Turn on or off the Backlight time function	
	Eddy	ON/OFF		Inverted Display	
SET	rdrH	ON/OFF		Allow the console to change the Address	
	DEFA	ON/OFF		Factory reset	
	FANS	AUe0/H19H/LOU		Setting the Fans' status	
	SAUE	OFF/1-999 150		Close the LED light when no signal	
	UEr	U1.0-U9.9		Software version	
Edit	SEPr	AUe0 IP01~IP10		Selecting the program that want to edit	
	StEP	S-01~ S-48		Setting the steppes of program	
	SCxx	C-01~C-xx		xxx(0-255)	Editing program by manual
		t INE		t xxx(001~999)	Running time
		Cedt		ON/OFF	Receiving build-in program from console or not
	rEC.	rE.xx			Recording senses automatically
rUN	ON/OFF			Program test	

Notes

Settings highlighted in light grey are default values.

DMX protocol

L336P - DMX Protocol								
Revision: A					Valid from firmware version: 1.0			
DMX mode		Name	DMX value		DMX percentage		Function	Default DMX Value
Standard (11ch)	Basic (7ch)							
1	1	Strobe/Shutter	0	31	0.0%	12.2%	Closed	0(0%)
			32	63	12.5%	24.7%	Open	
			64	127	25.1%	49.8%	Synchronous strobe from slow to fast	
			128	159	50.2%	62.4%	Open	
			160	223	62.7%	87.5%	Random strobe from slow to fast	
			224	255	87.8%	100.0%	Open	
2	2	Intensity	0	255	0.0%	100.0%	No light → Full light	0(0%)
3			0	65535	0.0%	100.0%	Intensity fade, fine (LSB)	
4	3	Red	0	255	0.0%	100.0%	No light → Full light	0(0%)
5			0	65535	0.0%	100.0%	Intensity fade, fine (LSB)	
6	4	Green	0	255	0.0%	100.0%	No light → Full light	0(0%)
7			0	65535	0.0%	100.0%	Intensity fade, fine (LSB)	
8	5	Blue	0	255	0.0%	100.0%	No light → Full light	0(0%)
9			0	65535	0.0%	100.0%	Intensity fade, fine (LSB)	
10	6	Rainbow Function	0	9	0.0%	3.5%	No function	0(0%)
			10	39	3.9%	15.3%	Rainbow scene 1	
			40	71	15.7%	27.8%	Rainbow scene 2	
			72	103	28.2%	40.4%	Rainbow scene 3	
			104	135	40.8%	52.9%	Rainbow scene 4	
			136	167	53.3%	65.5%	Rainbow scene 5	
			168	199	65.9%	78.0%	Rainbow scene 6	
			200	231	78.4%	90.6%	Rainbow scene 7	
			232	255	91.0%	100.0%	Rainbow flow from slow to fast	

DMX mode		Name	DMX value		DMX percentage		Function	Default DMX Value
Standard (11ch)	Basic (7ch)							
11	7	Color temperature	0	24	0.0%	9.4%	No function	0(0%)
			25	35	9.8%	13.7%	3200K	
			36	46	14.1%	18.0%	3400K	
			47	57	18.4%	22.4%	3600K	
			58	68	22.7%	26.7%	3800K	
			69	79	27.1%	31.0%	4000K	
			80	90	31.4%	35.3%	4200K	
			91	101	35.7%	39.6%	4400K	
			102	112	40.0%	43.9%	4600K	
			113	123	44.3%	48.2%	4800K	
			124	134	48.6%	52.5%	5000K	
			135	145	52.9%	56.9%	5200K	
			146	156	57.3%	61.2%	5400K	
			157	167	61.6%	65.5%	5600K	
			168	178	65.9%	69.8%	5800K	
			179	189	70.2%	74.1%	6000K	
			190	200	74.5%	78.4%	6200K	
			201	211	78.8%	82.7%	6400K	
			212	222	83.1%	87.1%	6600K	
			223	233	87.5%	91.4%	6800K	
234	244	91.8%	95.7%	7000K				
245	255	96.1%	100.0%	7200K				

 **Notes**

Do not switch off the fixture within the first minute after switching on. Wait for at least 5 minutes to switch on the fixture.

Technical specification

Optical

- Light source: LED 3W (12 red, 12 green, 12 blue), quantity: 36pcs
- Expected average lifetime: 50000 hours
- Beam angle: 25° x 29°(50% peak angle), 44° x 52°(10% peak angle)
- RGB linear color mixing.

Electrical

- Power input, nominal: AC 100-240V, 50/60Hz
- Max. Power consumption: 105W, max current: 0.96A, PF≥ 0.99
- Power supply unit: Auto-ranging electronic SMPS

Control and programming

- Control channels (DMX): 11/7
- Protocol: DMX-512
- Display: 4 x 8 segment display

Physical / Installation

- Weight: 5 kg (11 lbs.)
- IP rating: IP65
- Material: Aluminium, steel, plastic
- Minimum distance to combustible materials: 1.64ft. (0.5m)
- Minimum distance to illuminated surfaces: 3.28ft. (1m)

Dynamic effects

- Pan/Tilt movement: Manually adjustable
- Strobe: 1-25Hz, synchronized, pulse effects
- Dimmer: 0-100%, 16-bit, electronic linear dimming

Thermal

- Operating range: 14°F to 113°F (-10°C to +45°C)
- Startup range: 5°F to 113°F (-15°C to +45°C)
- Storage range: -40°F to 140°F (-40°C to +60°C)
- Cooling: Passive
- Humidity: ≤98%

Connections

- AC power: 1m (3.28 ft.) cable with water proof plugs (in/out)
- DMX data input/output: 2 x 1m (3.28 ft.) cable with 5-pin Neutrik IP65 XLR plugs (in/out)

Certification and Safety

- EMC: EN 55103-1:2009, EN 55103-2:2009, EN 61000-3-2:2006+A2:2009, EN 61000-3-3:2013
- Safety: EN 60598-2-17:1989/A2:1991

Photometric

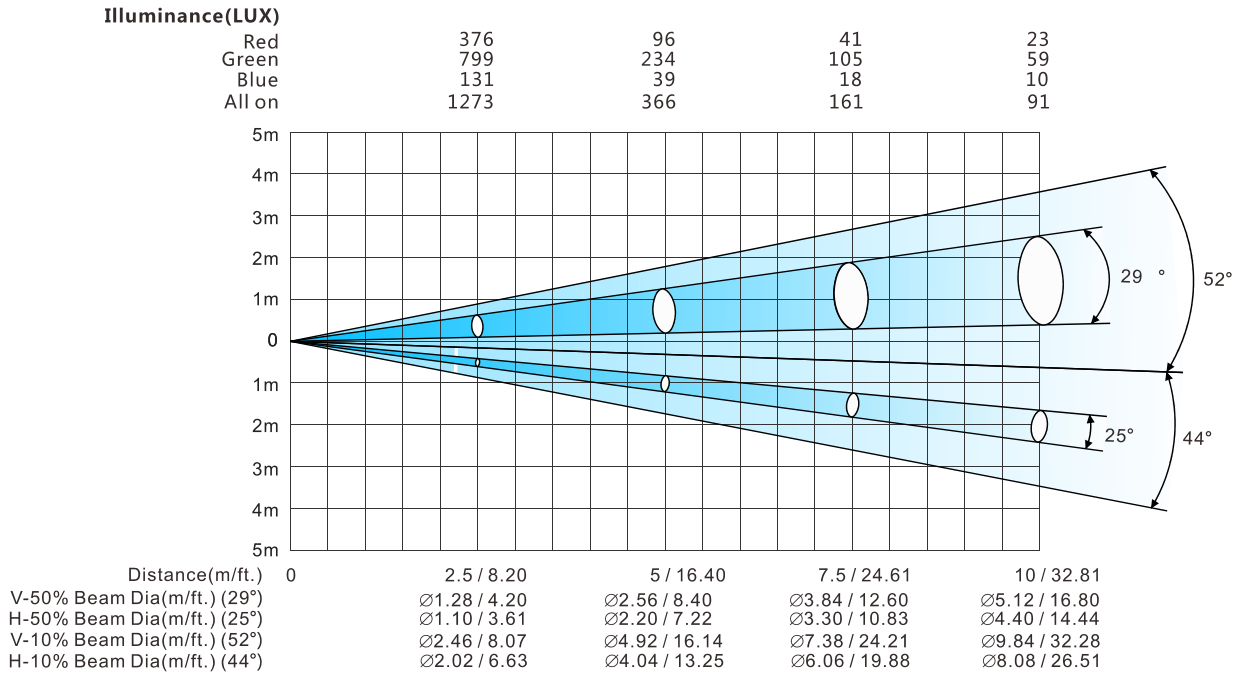

Cleaning and maintenance

It is required that the fixture should be kept clean and well maintained to ensure its reliability. Its lifespan mainly depends on the working environment and proper operation. Should you have any questions, please consult a technical engineer of GTD Lighting.

⚠Notes

Damage resulted from dust, smoke, oil or improper use is not covered by warranty.

⚠Warning

Disconnect the fixture from AC power, and let it cool down for at least 15 minutes before opening the housing. Make sure to use a soft cloth to clean the optical components, and be careful, as the coating is easily scratched. Do not use any organic solvent such as alcohol to clean the reflector mirror, dichroic color filters or housing of the fixture.

- If the lens is cracked or otherwise damaged, replace it immediately.
- If the LED lamp becomes damaged or deformed in any way it must be replaced.
- If the light from the LED lamp appears dim, this normally indicates that it is reaching the end of its life span and should be changed at once. Aged LED lamps run to the extremity of their life might explode.
- If fixture does not function, check the fuse on the power socket of the fixture. Replace the fuse of the same specification if it is blown.
- The fixture is equipped with thermal-protection device that will switch off the LED lamp in case of overheating. If this happens, please check that the fans are not blocked, and clean them if they are dirty. Check whether the fans are operational. If not, call a qualified technician. Troubleshoot and correct the problem before switching on the fixture again. Any maintenance work should only be carried out by qualified technicians.

Troubleshooting

Problem	Possible Cause	Suggested Correction
No response after connected to A/C power	Power switch not turned on.	Turn on power switch.
	Take out the fuse and check if it is blown.	Locate the blown fuse. Remove the broken fuse. Insert a replacement fuse of the correct amperage.
	Abnormal A/C input (A/C power socket, power cables, luminaire power socket).	Replace AC power socket and power cables, and then adjust power socket for proper connection.
	No DC voltage from switching power supply.	Check if the switching power supply has DC voltage output. Replace the switching power supply.
No response or wrong response to the commands of the control system	DMX cables disconnected from fixture's DATA IN connector.	Connect DMX cable to the fixture's DATA IN connector.
	Open circuit or short circuit fault in the DMX cables.	Replace DMX cables as required.
	Wrong DMX address for the fixture in the control system.	Ensure the address in "Run setting > Address Setting > Address" of the fixture is consistent with the address in the control system.
	Misuse in "Channel setting > Channel Mode" of the fixture.	Choose the channel mode in "Channel setting > Channel Mode" of the fixture as required by the user.
	Malfunctioning of DMX cannon input/output connectors. No input/output voltage to the main control board of the fixture.	Troubleshooting the DMX XLR signal plate of the fixture, replace the main control board of the fixture.
LED lamp off	There is no signal output to the main control board PWM.	Replace the main control board or repair.
	No output to the drive board LED +/- LED- or drive board over-current, check line connector if contact bad.	Reconnect the terminal, replace the driver board
	Normal end of LED lamp life, bad welding or poor heat dispersion.	Repair or replace LED light source or replace the whole piece of aluminum board, remove the cooling system failure.
Decreased brightness, uneven pattern projections	LED lamp aging, check the service time of LED light source, test LED drive board's current.	Replace the LED light source or adjust the drive board's current. Reduce LED's brightness.
	Excessive dusts or smudges on the effect assembly, focus module and objective lens.	Follow the instructions stated in this user manual to clean the effect assembly, focus module and objective lens.
	Damaged or deformed effect assembly, focus module or objective lens.	Replace the damaged or deformed components.

System wiring diagram

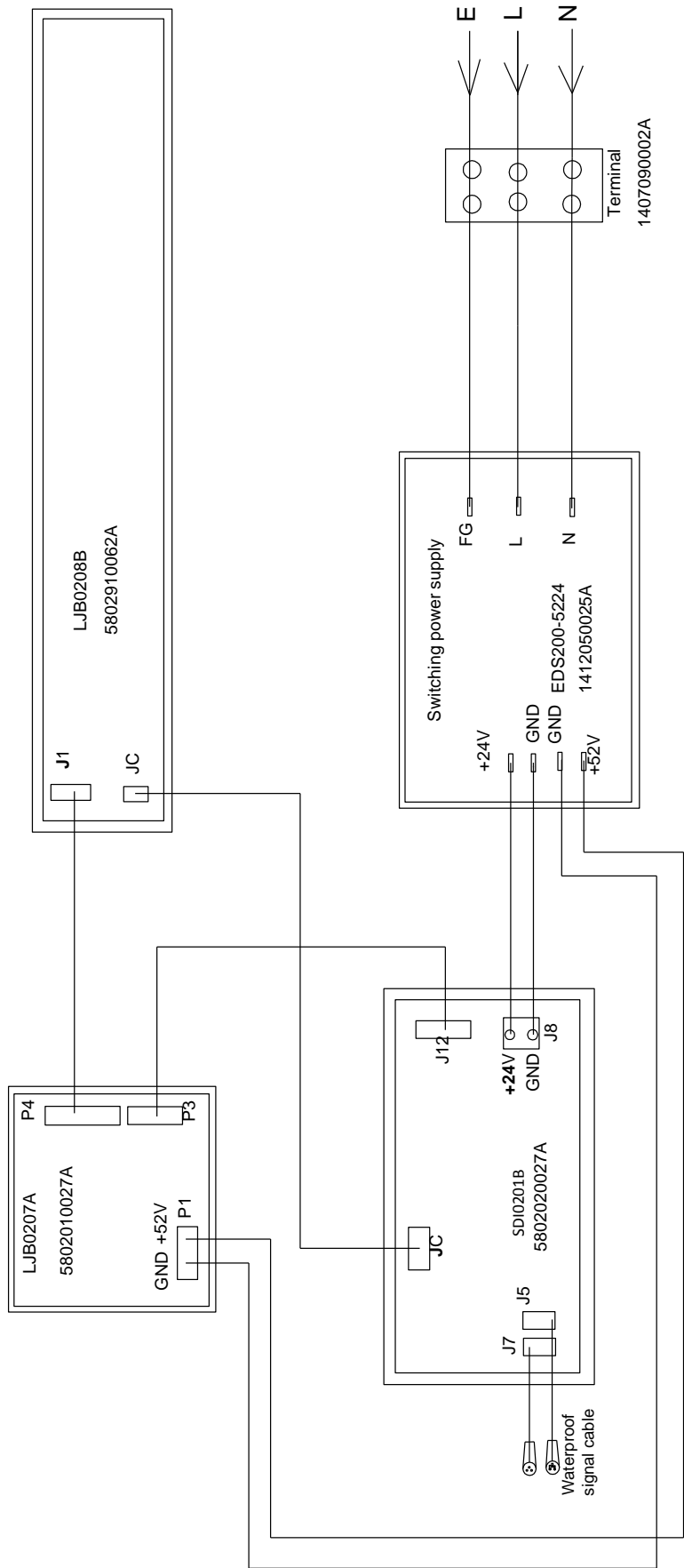

GTD-L336P

Spare parts list

Item	P/N	Qty	Notes
Switching Power Supply	1412050025A	1	EDS150-5224P
Aluminum substrate	5802010027A	2	LJB0207A
LED lamp board	5802910062A	1	LJB0208B
Display board	5809210043A	1	L336P-101E10&102F10 SDI0201B

Appendix 1

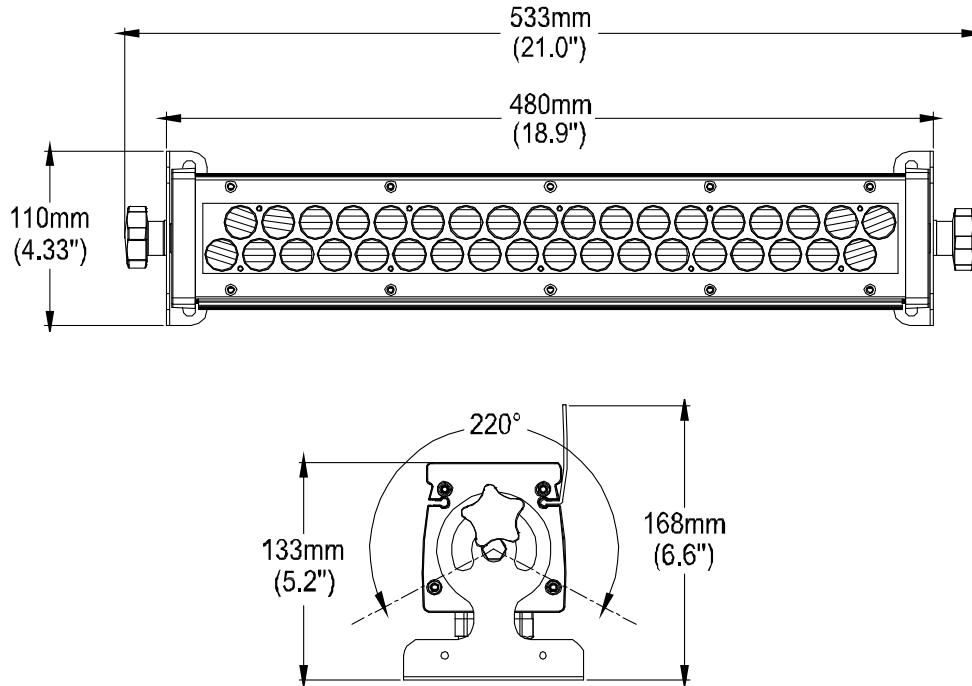

Notes:

P/N: 1502011029A

Time: June 3rd, 2017